

Reference Guide for the D7024 Control/Communicator



Radionics[™]

Radionics, Inc., 1800 Abbott Street
Salinas, CA 93901, U.S.A.
Customer Service: (800) 538-5807

6/20/97

Table of Contents

Notices	3	7.0 Programming Menu Tree (PROG/0)	19
FCC Compliance Notice	3	8.0 Menu Tree (CMND#, TEST, HISTORY, DISABLE, DRILL)	21
FCC Phone Connection to Users Notice	3	9.0 Installation Guide for U.L. Listed Systems	22
1.0 Overview	4	9.1 D7024 U.L. Listings	22
1.1 System Overview	4	9.2 Installation Considerations	22
1.2 Specifications	4	9.3 Programming the D7024	22
1.2.1 Enclosure Housing	4	9.4 Reversing Modules	22
1.2.2 Temperature	4	Appendix A: Abbreviations on Panel Display	23
1.2.3 Power	4	Appendix B: Defaults for PROG/0	24
1.2.4 Outputs	4	Index	26
1.2.5 Zones (Initiating Circuits)	4		
1.2.6 Keypads	5		
1.2.7 Communicator	5		
1.2.8 Users	5		
1.2.9 Lightning Protection	5		
1.2.10 Backup Battery Calculation	5		
1.2.11 Standby Current Load	5		
2.0 Enclosure Installation	6		
2.1 Install the Enclosure	6		
2.2 Install the Control/Communicator	6		
3.0 Control Terminal Wiring	7		
4.0 System Worksheet	8		
5.0 Operating Guide	11		
5.1 Understanding the Built-in Keypad	11		
5.2 Understanding the D7033 Keypad	11		
5.3 System Operation	12		
5.3.1 Modes of System Operation	12		
5.3.2 Point/Zone Mapping	12		
5.4 Fire Silence/Reset	13		
5.5 System Trouble	13		
5.6 Fire Safety	13		
5.6.1 If Installed in Family Residences	14		
5.6.2 Having and Practicing an Escape Plan	14		
5.6.3 Installation Considerations	14		
5.7 Personal Identification Numbers	15		
5.8 Error Displays	15		
5.9 Testing	15		
5.10 Remote Program Dial-out and Answer	16		
6.0 How to Program	17		
6.1 ALPHA Programming	18		
6.2 Format Programming	18		
6.2.1 4/2	18		
6.2.2 BFSK	18		
6.2.3 SIA	18		

Notices

FCC Compliance Notice

This equipment has been tested and found to comply with the limits for a Class A digital device, pursuant to Part 15 of the FCC Rules. These limits are designed to provide reasonable protection against harmful interference in a residential installation. This equipment generates, uses and can radiate radio frequency energy and if not installed and used in accordance with the instructions, may cause harmful interference to radio communications. However, there is no guarantee that interference will not occur in a particular installation. If this equipment does cause harmful interference to radio or television reception, which can be determined by turning the equipment off and on, the user is encouraged to try to correct the interference by one or more of the following measures:

- Re-orient or relocate the receiving antenna.
- Increase the separation between the equipment and the receiver.
- Connect the equipment into an outlet on a circuit different from that to which the receiver is connected.
- Consult the dealer or an experienced radio/TV technician for help.

FCC Phone Connection to Users

This control complies with Part 68 of the FCC rules.

On the inside of the enclosure is a label that contains, among other information, the FCC Registration Number and the Ringer Equivalence Number (REN) for this equipment. You must, upon request, provide this information to your local telephone company.

The REN is useful to determine the quantity of devices that may be connected to your telephone line and still have all of those devices ring when your telephone number is called. In most, but not all areas, the sum of the REN's of all devices connected to one line should not exceed five (5.0). To be certain of the number of devices that you may connect to your line, you may want to contact your local telephone company to determine the max. REN for your local calling area.

This equipment may not be used on coin service provided by the telephone company. This control should not be connected to party lines.

Should this equipment cause harm to the telephone network, the telephone company may discontinue your service temporarily. If possible, they will notify you in advance. But if advanced notice isn't practical, you will be notified as soon as possible. You will be informed of your right to file a complaint with the FCC. The telephone company may make changes in its facilities, equipment, operations, or procedures that could affect the proper functioning of your equipment. If they do, you will be notified in advance to give you an opportunity to maintain uninterrupted telephone service.

If you experience trouble with this equipment, please contact the manufacturer for information on obtaining service or repairs.

The telephone company may ask that you disconnect this equipment from the network until the problem has been corrected or until you are sure that the equipment is not malfunctioning. The repairs to this equipment must be made by the manufacturer and not the user.

To guard against accidental disconnection, there is ample room to mount the Telco jack to the inside of the Control cabinet.

The operation of this Control may also be affected if events such as accidents or acts of God cause an interruption in telephone service.

Notice

The Industry Canada label identifies certified equipment. This certification means that the equipment meets certain telecommunications network protective, operational, and safety requirements. Industry Canada does not guarantee the equipment will operate to the user's satisfaction.

Before installing this equipment, users should ensure that it is permissible to be connected to the facilities of the local telecommunications company. The equipment must also be installed using an acceptable method of connection. The customer should be aware that compliance with the above conditions may not prevent degradation of service in some situations.

Repairs to certified equipment should be made by an authorized Canadian maintenance facility designated by the supplier. Any repairs or alterations made by the user to this equipment, or equipment malfunctions, may give the telecommunications company cause to request the user to disconnect the equipment.

Users should ensure for their own protection that the electrical ground connections of the power utility, telephone lines and internal metallic water pipe system, if present, are connected together.

Caution: Users should not attempt to make such connections themselves, but should contact the appropriate electric inspection authority, or electrician, as appropriate.

1.0 Overview

1.1 System Overview

The D7024 Control/Communicator is a fully integrated hard-wire fire alarm system. It can support 4 input points (expandable to 8) and 16 individual users. The control panel has a built-in LCD keypad, however, up to 4 additional keypads may be used to provide user interface with the system and programming access for the installer. The D7024 also includes the following features:

- Built-in Dual-line Communicator
- Menu Driven Keypad Programming
- Freely Programmable Alpha Display
- 100 Event History Buffer
- 16 User Codes
- U.L. Listed, C.S.F.M. Approved

1.2 Specifications

1.2.1 Enclosure Housing

The standard enclosure is manufactured from 18 Ga., cold-rolled steel, and measures 15 in. Wide, by 20.75 in. High, by 4.25 in. Deep (38.1 cm Wide, by 52.7 cm High, by 10.8 cm Deep). A keyed lock is included, and the LEDs and display are visible through the door.

1.2.2 Temperature

- Storage and Operating Temperature:
+32° to +120°F (0° to +49°C)

1.2.3 Power

- Input Power:
120 V, 60 Hz, 1.5 A (max. 20 A fused)
- Notification Appliance Circuit Power:
24 VDC nominal, unfiltered (special application) with up to 2.5 A capacity (but limited by overall 4.0 A capacity). Refer to Technogram P/N 34950B for compatible devices
- Auxiliary Power:
24 VDC nominal, unfiltered (special application)
Refer to Technogram P/N 34950B
- Initiating Circuit (Smoke) Power:
24 VDC nominal
Refer to Technogram P/N 34445B
- Option Bus Power:
12 V +/- 5%, 500 mA
- Optional Standby Batteries:
Two 12 V (in series), 7 - 40 AH

1.2.4 Outputs

- 2 on-board notification circuits - NAC 1 and NAC 2. These are 24 V outputs for notification devices with up to 2.5 A capacity (but limited by overall 4.0 A capacity) on each circuit.
- Wired for standard Class B operation.
- Local Relays: The main panel includes two Form "C" relays. The relay contacts are rated at 6 A, 24 VDC. No transient suppression or overcurrent limiting are performed on the contacts of these relays. The default selection for the relays is to indicate general alarm and general system trouble. By programming them to one or two of the zone numbers described for point/zone mapping, they can be programmed to activate on a variety of conditions.
- Remote Relay Module (D7035): The D7035 is an Octal Relay Module that provides 8 Form "C" relay outputs. It connects to the D7024 via the option bus. The outputs are fully programmable, exactly as the local relays are programmed. Each output operates independently of the other 7 to provide complete flexibility. Communication with the D7035 is supervised.

1.2.5 Points (Initiating Circuits)

All points work with 2 or 4-wire detectors. The system has an optional alarm verification feature.

- Number of 2-wire Circuits:
4 circuits, expandable to 8
- Type of Circuit:
Class B, Style B
- End-of-Line Resistor:
2.21k ohms, P/N 25899 U.L. Listed
- Supervisory Current:
8 - 20 mA
- Required Current for Alarm:
25 mA
- Maximum Short Circuit Current:
44 mA
- Maximum Line Resistance:
150 ohms
- Circuit Voltage Range:
20.4 to 28.2 VDC
- Maximum Detectors per Point:
20 detectors (2-wire)
- Total Detector Standby Current:
3 mA max.
- Response Time:
500 milli-seconds and programmable from 1 second to 15 seconds.

1.0 Overview (continued)

1.2.6 Keypads

- Maximum # of keypads:
4 D7033 keypads
- Maximum wire length each:
1000 feet
- Maximum wire length total:
4000 feet in system
- Wire type:
4 conductor, unshielded, #22 AWG (0.8 mm)
"Telephone quad" or #18 AWG (1.0 mm) quad
wiring can be home-run or daisy-chained.

Note: No more than 2 keypads recommended on any 1000 foot run.

Note: Shared cable is not recommended for keypad, multiplex, options bus, telephone, or siren wiring.

1.2.7 Communicator

Will report to two (2) phone numbers with full single, double, and back-up reporting. Communicates in SIA, Contact ID, BFSK, and 4/2 Tone burst formats.

1.2.8 Users

The system allows up to 16 individual users. Each user can have his own PIN number (the 4 digit code entered at the keypads) and his own authority level (to determine which functions he may perform).

1.2.9 Lightning Protection

MOVs and spark gaps provide protection from lightning surges and static discharges.

1.2.10 Backup Battery Calculation

- The following table is used to calculate the standby battery capacity required by NFPA when using the D7024:

Device	Quantity	Standby Current Per Device	Total Standby Current (Quantity x Standby Current Per Device)	Alarm Current Per Device	Total Alarm Current (Quantity x Alarm Current Per Device)
D7033 Keypad		100 mA		100 mA	
D7034 - 4 Point Expander		44 mA		**	
D7035 - Octal Relay*		10 mA + 40 mA*		10 mA - 40 mA*	
Smoke Detectors				**	
Bells, Horns, etc.					
Other sensors					
Other					
Grand Total				Grand Total	

* = When calculating Standby and Alarm Current for the Octal Relay Module, use 10 mA plus 40 mA for each activated relay.

** = Will not exceed 40 mA per loop in alarm.

1.2.11 Standby Current Load

- Battery AH - (20% Storage + 0.375 AH's Alarm)
- The following table is the derated battery divided by hours minus the control standby (175 mA):

Rechargeable Battery Size	Max. Standby for 24 hours	Max. Standby for 48 hours	Max. Standby for 60 hours	Max. Standby for 72 hours	Max. Standby for 80 hours
7 AH	X	X	X	X	X
8 AH	80 mA	X	X	X	X
14 AH	280 mA	50 mA	X	X	X
15 AH	310 mA	70 mA	X	X	X
17.2 AH	380 mA	100 mA	50 mA	X	X
21 AH	510 mA	170 mA	100 mA	50 mA	X
28 AH	740 mA	280 mA	190 mA	130 mA	100 mA
30 AH	810 mA	320 mA	220 mA	150 mA	120 mA
33 AH	910 mA	370 mA	260 mA	190 mA	150 mA
35 AH	980 mA	400 mA	290 mA	210 mA	170 mA
38 AH	1080 mA	450 mA	330 mA	240 mA	200 mA
40 AH	1140 mA	480 mA	350 mA	260 mA	220 mA

Note: When batteries larger than 17.2 AH are used, an optional battery enclosure (Wheelock BATC-R) must be used. Battery wires must be #12 AWG (2.1 mm).

2.0 Enclosure Installation

The D7024 control/communicator and the enclosure are shipped together. The control, however, still needs to be installed into the enclosure. Hardware for mounting the enclosure to a wall, and the control to the enclosure is located in the hardware pack.

2.1 Install the Enclosure

- Use the enclosure as a template and mark the top mounting holes on the mounting surface.
- Pre-start the mounting screws for these two holes. Slide the enclosure onto these mounting screws so that the screws move up into the thinner section of the holes. Tighten the screws.
- Screw in the remaining two screws in either set of bottom mounting holes.
- Knock out the desired wire entrances on the enclosure.

2.2 Install the Control/Communicator

CAUTION: The control is static sensitive. Make sure you touch ground before handling the control. This will discharge any static electricity in your body. Example: Run the ground wire to the enclosure before handling the control. Then keep holding the ground wire while installing the control.

- Insert the two support posts into the control retainer holes as shown in the diagram below.
- Press the 1/8" nylon standoffs into the control retainer holes as shown. This provides support behind the control.
- Slide the top of the control into the retainer tabs (the slots under the top of the frame).
- Once in the retainer tabs, the control will rest on the two support posts.
- Secure the bottom of the control by screwing the 2 bottom corners through the support posts and through to the control retainer holes.

CAUTION: Once the control is installed, be sure to connect the supplied ground wire between the door and the enclosure using the supplied nuts.

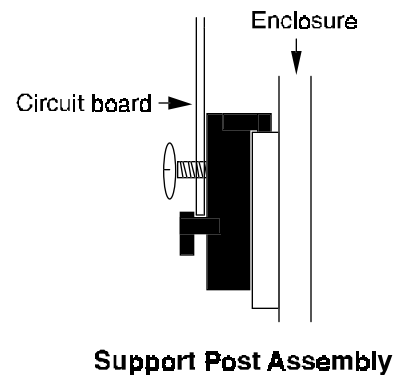
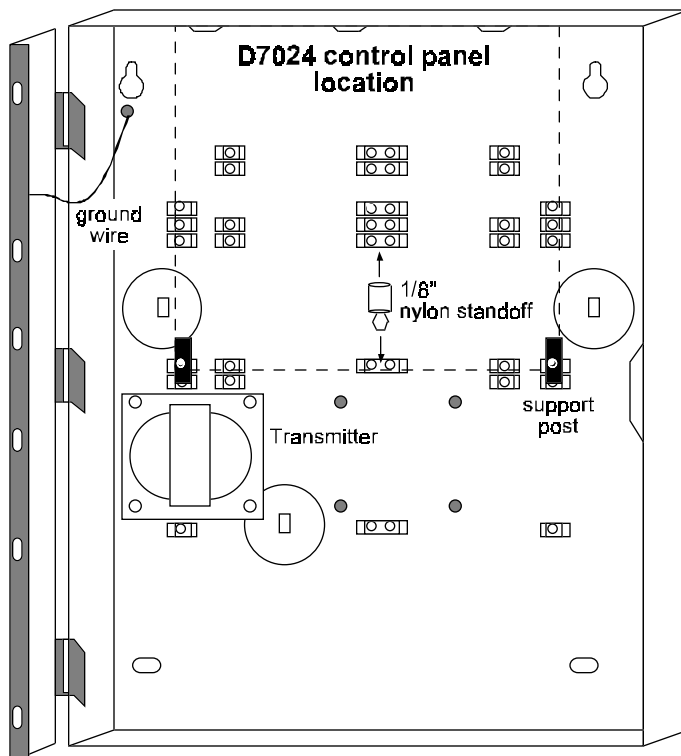

3.0 Control Terminal Wiring

WARNING: Before servicing this equipment, remove all power including the transformer, battery, and phone lines. A complete functional test is required after any programming.

CAUTION: Incorrect connections may result in damage to the unit.

NOTE: Shared cable is not recommended for option bus, telephone, or NAC wiring.

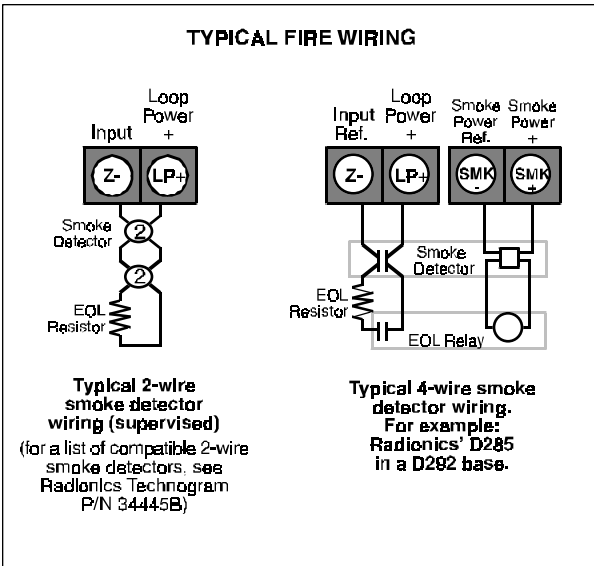
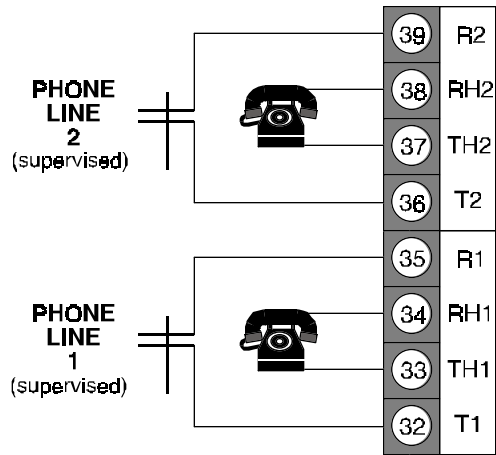

unsupervised	Relay 2	NC2	31
		COM2	30
		NO2	29
unsupervised	Relay 1	NC1	28
		COM1	27
		NO1	26
supervised	Smoke Power 24V, 1.0A max	SMK+	25
		SMK-	24
unsupervised	Auxiliary Power 24V, 1.0A max (unfiltered)	AUX+	23
		AUX-	22

For connection to listed power limited Class 2 or Class 3 sources only.

Refer to Technogram P/N 34950B

Connect primary side of transformer (black and white wires) to unswitched 120 V, 60 Hz circuit using wire nuts. Connect earth ground to the threaded ground stud on the left side of the

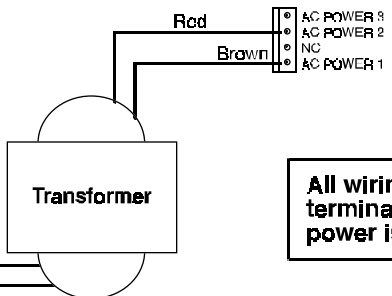

All wiring except battery terminal and primary AC power is power limited.

EARTH GROUND		21	Refer to Technogram P/N 34950B
INPUT POINTS 1-4: (supervised) Points are intended for connection of Normally Open/Normally Closed alarm contacts. They may also be used for compatible 2-wire smoke detectors. All End-of-Line resistors are P/N 2588B, U.L. Listed. Initiating devices are Class B, Style B.	4-	20	
	L+	19	
	3-	18	
	2-	17	
	L+	16	
	1-	15	

	1	NAC 1 +	NOTIFICATION APPLIANCE CIRCUIT: +24 V while in alarm, ground while in standby.
	2	NAC 1 -	
	3	NAC 2 +	NOTIFICATION APPLIANCE CIRCUIT: +24 V while in alarm, ground while in standby.
	4	NAC 2 -	
	5	BAT -	BATTERIES: Requires two 12 V batteries, in series, for a combined voltage of 24 V. Charge Current = 1.1A, max. Caution: Do not short terminals - explosion and burn hazard.
	6	BAT +	

Use only Indicating Devices as listed on Technogram P/N 34950B

supervised, Style 4
Option Power (A + B) 500mA, max

Option Bus A				Option Bus B			
R	B	G	Y	R	B	G	Y
7	8	9	10	11	12	13	14
+12	Com	Data 15mA, max		+12	Com	Data 15mA, max	

4.0 System Worksheet (continued)

Personal Identification Numbers

Example

	PIN Number	Authority Level	Name
User 00	1001	3	Henry M. Jones

	PIN Number	Authority Level	Name
User 00			
User 01			
User 02			
User 03			
User 04			
User 05			
User 06			
User 07			
User 08			
User 09			
User 10			
User 11			
User 12			
User 13			
User 14			
User 15			

4.0 System Worksheet (continued)

Keypad Location

Keypad #1 _____
 Keypad #2 _____
 Keypad #3 _____
 Keypad #4 _____

Point Location and Notes

Example

	Device(s)	Location(s)	Type
Point 1	Smoke Detector	Hallway	Fire, Alarm on Short, Latching, Verification

	Device(s)	Location(s)	Type
Point 1			
Point 2			
Point 3			
Point 4			
Point 5			
Point 6			
Point 7			
Point 8			

5.0 Operating Guide

5.1 Understanding the Built-in Keypad

The keypad built-in to the control/communicator is an alpha-numeric LCD keypad. It has a two line by 16 character display to provide information on various control panel functions. In most instances, the top line of the display provides general system status information, while the second line describes specific devices that may be relevant to the current system status. When keys are being pressed, the display usually shows the current action on the top line, while displaying rotating menu choices on the second line. A built-in sounder is used to annunciate keystroke entries and as an interior warning device.

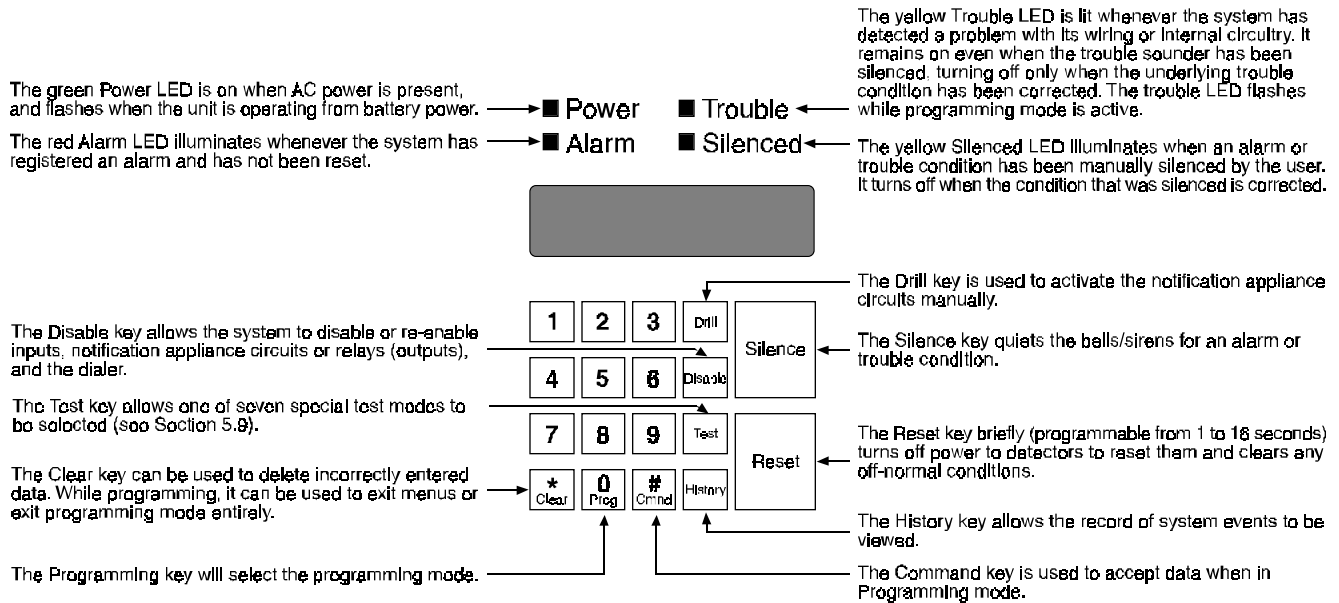

5.2 Understanding the D7033 Keypad

The D7033 keypad is an alpha-numeric LCD keypad. Up to four of these keypads can be mounted apart from the main control/communicator to provide additional locations for system status and control. The LCD display and keys operate identically to those of the built-in keypad on the control panel.

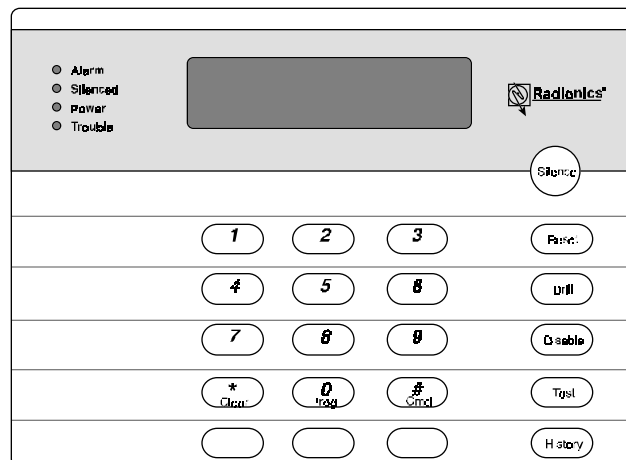

The volume and backlight intensity of the D7033 keypad can be changed in the following manner:

- **Volume Control** - The keypad sounder volume can be adjusted using the [1] and [4] keys along with the [*] key.
 - Hold the [*] key while pressing the [1] key to increase the volume or the [4] key to decrease the volume.
- **Backlight Control** - The display backlight intensity can be adjusted using the [3] and [6] keys along with the [*] key.
 - Hold the [*] key while pressing the [3] key to increase the brightness or the [6] key to decrease the brightness.

5.0 Operating Guide (continued)

5.3 System Operation

5.3.1 Modes of System Operation

There are three modes of system operation for the D7024 control/communicator:

- **Normal Operation:** When the system is operating normally, it displays "SYSTEM NORMAL" on the top line of the display, the Power LED is on steady, and no other LEDs are lit. If the system is programmed to require a PIN, the second line of the LCD screen will display "ENTER PIN:", otherwise the control panel will bypass this display and will show a rotating menu of possible user actions.
- **Alarm Operation:** When an alarm occurs, the top line of the display will show "FIRE ALARM". This display will override any other system display. The second line of the display will show the number of the point that is in alarm, alternating with the programmed description for the affected point. If more than one alarm (or other off-normal condition) is active, they will be shown on the second line of the display, one after another. The built-in sounder turns on with a steady tone, and outputs programmed to activate with the current alarm condition(s) will activate.
- **Trouble Operation:** When a trouble condition occurs (e.g. wiring for a point is cut, AC power fails, etc.), the sounder will activate briefly, every 10 seconds. The Trouble LED will light and the top line of the display will show "SYSTEMTROUBLE". The second line of the display will identify the specific problem.

5.3.2 Point/Zone Mapping

The panel supports a system to map the input points to output points.

Input points are assigned, during installation, to a zone. Each input point can be assigned to only one zone; however, multiple input points can be assigned to the same zone. Output points are also assigned; however, they can be assigned to up to four different zones. This allows an alarm condition on an input device assigned to zone one to cause all of the output devices assigned to zone one to activate.

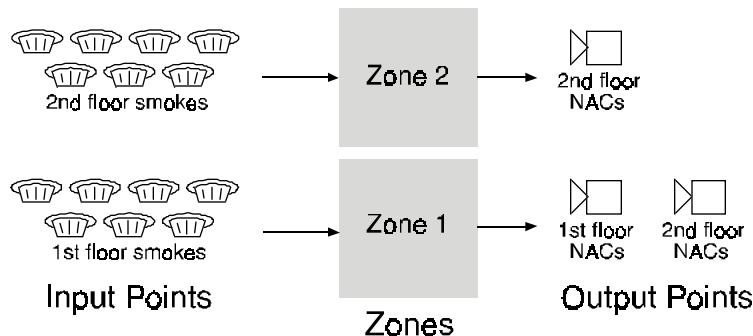

Assign input points to zones in [PROG/0] [4-PROG INPUTS] [3-ZONE ASSIGN]. Remember, each input point can only be assigned to one zone; however, a zone can have multiple input points assigned to it. In our graphic, above, there are 7 smoke detectors assigned to each zone. Output points (NACs) are assigned in [PROG/0] [5-PROG OUTPUTS] [3-ZONE ASSIGNS]. Here, individual output points can be assigned to up to four zones. This allows a smoke detector on the first floor of a building (assigned to zone 1) to cause horns (also assigned to zone 1) to sound on floors 1 and 2.

Up to 64 zones can be assigned. Zones 1 to 50 can be assigned by the installer. Zones 51 to 63 are preassigned to system conditions.

Preassigned Zones:

- Zone 63: General Alarm - active while any alarm, including supervisory, is present; remains active even while system is silenced.
- Zone 62: General Trouble - active while any system trouble is present.
- Zone 61: General Waterflow - active while any waterflow alarm is present.

5.0 Operating Guide (continued)

- Zone 60: No AC - active when AC power fails.
- Zone 59: Alarm Verification - active while alarm verification is in progress, starting with the first detection of an alarm to be verified and clearing at the end of the five second power stabilization time.
- Zone 58: General Supervisory Alarm - active when any supervisory alarm condition is present.
- Zone 57: Communication Trouble - active when the dialer has failed to communicate, or all monitored phone lines are indicating line fault; remains active until communication through the digital communicator has been restored.
- Zone 56: Presignal or Alarm Investigation Delay Active - active during the time after a zone or point has been tripped, but before the NACs are activated.
- Zone 55: Releasing Cycle Started - active after two detectors have been tripped to start a releasing cycle; clears when the release occurs or is aborted.
- Zone 54: Activates for ground start.
- Zone 53: General Fire Alarm - active when a fire alarm condition is present; does not activate for waterflow.
- Zone 51 to 53 are reserved for future use.

5.4 Fire Silence/Reset

During a fire alarm, exit the premises immediately. Do not enter the premises unless accompanied by the appropriate Emergency Services' personnel, or after they have given the OK to enter. When it has been determined that there is no fire, you may silence the horns/bells to allow further investigation of the devices that initiated the alarm, or you may reset the system to return it to normal operation.

Before the [Reset] key is used, determine which smoke detector has alarmed so the monitoring company may verify its operation.

The [Silence] key turns off the horns/bells, but does not reset the alarm status and does not return the tripped input to normal service. Detectors that were tripped will stay in alarm and can be checked (usually by means of an LED on the device) to see which detector caused the alarm. Once the detectors causing the alarm have been identified, the system should be reset to return it to normal service.

The [Reset] key clears the system alarm status, and briefly turns off power to the detectors to reset them. This command is required after any fire alarm affecting a point programmed for latching operation (which is the normal configuration).

5.5 System Trouble

A system trouble will be indicated by a short beep from the panel or keypad sounders every 10 seconds. The LCD will display "SYSTEM TROUBLE", followed by a description of the trouble condition. The system can diagnose and display a variety of trouble conditions, including those affecting the input points, NAC circuits, power, battery, system grounding, and internal operations of the fire control panel. Notify your installing company immediately if the system trouble message is displayed.

The system trouble beep can be silenced with the [Silence] key. After problems have been remedied, [Reset] should be pressed to clear the "SYSTEM TROUBLE" display.

5.6 Fire Safety

WARNING: No fire detection device or system should be considered 100% foolproof.

This fire alarm system can provide early warning of a developing fire. Such a system, however, does not ensure protection against property damage or loss of life resulting from a fire. Any fire alarm system may fail to warn for any number of reasons (e.g. smoke not reaching a detector that is behind a closed door).

When considering detectors for residential applications, refer to NFPA Standard 72, "The National Fire Alarm Code." This standard is available at a nominal cost from: The National Fire Protection Association, Batterymarch Park, Quincy, MA 02269.

5.0 Operating Guide (continued)

5.6.1 If Installed in Family Residences

Adherence to NFPA Standard 72 can lead to reasonable fire safety when the following items are practiced:

- **Minimize hazards:** Avoid the three traditional fire killers: smoking in bed, leaving children home alone, and cleaning with flammable liquids.
- **Providing a fire warning system:** Most fire deaths occur in the home, the majority, during sleeping hours. The minimum level of protection requires smoke detectors to be installed outside of each separate sleeping area and on each additional story of the dwelling.

For added early warning protection, it is recommended that detectors be installed in all separated areas including the basement, bedrooms, dining room, utility room, furnace room, and hallways.

5.6.2 Having and Practicing an Escape Plan

A fire warning may be wasted unless the family has planned in advance for a rapid and safe exit from the building.

- Draw a floor plan of the entire house showing **two** exits from each bedroom and **two** from the house. Since stairwells and hallways may be blocked during a fire, the plan should provide exits from bedroom windows. Make copies of the plan and practice it with all family members.
- Pre-arrange a meeting place **outside and away from** the residence. Once out of the building, all occupants should immediately go to the pre-selected location and be accounted for.
- Provide a barricade between family members and fire, smoke, and toxic gases (e.g. close all bedroom doors before retiring).
- Children should be instructed on opening their bedroom windows and exiting safely from the building. If exiting is not possible, they should be taught to stay at the open window and shout for help until it arrives.
- In the event of a fire alarm after retiring, wake the children by shouting to them from behind your closed door. Tell them to keep their bedroom doors closed.
- **If the top of your bedroom door is uncomfortably hot, do not open it.** There is most likely fire, intolerable heat, or smoke on the other side. Shout to all family members to keep their bedroom doors closed and to exit the building via alternate routes.
- If the top of the door is not uncomfortably hot, brace the bottom of the door with your foot, and the top with one hand, then open the door about one inch. Be prepared to slam the door shut if there is any pressure against the door or if any hot air rushes in.
- If there is no evidence of excessive heat or pressure, **leave the room and close the door behind you.** Shout appropriate instructions to all family members and immediately leave the building via the pre-planned routes. If heavy smoke is present, drop to your hands and knees, or crawl to remain below the smoke level.

5.6.3 Installation Considerations

Proper location of detection devices is one of the most critical factors in a fire alarm system (see text below and the figure at the top of the next page).

The following are some general considerations:

- Smoke detectors should **not** be installed in “dead air” spaces or close to ventilating or air conditioning outlets because smoke may be circulated away from the detector. Locations near air inlets should be favored.
- Avoid areas subject to normal smoke concentrations such as kitchens, garages, or near fireplaces.
- Do not install smoke detectors where normal area temperatures are above 100 degrees F (38 degrees C) or below 32 degrees F (0 degrees C).
- Areas of high humidity and dust concentrations should be avoided.
- The edge of ceiling mounted detectors should be no closer than 4 inches (10 cm) from any wall.
- Place the top edge of wall mounted detectors between 4 and 12 inches (10 and 30 cm) from the ceiling.

For exact mounting information, refer to the instructions provided with the smoke detectors.

5.0 Operating Guide (continued)

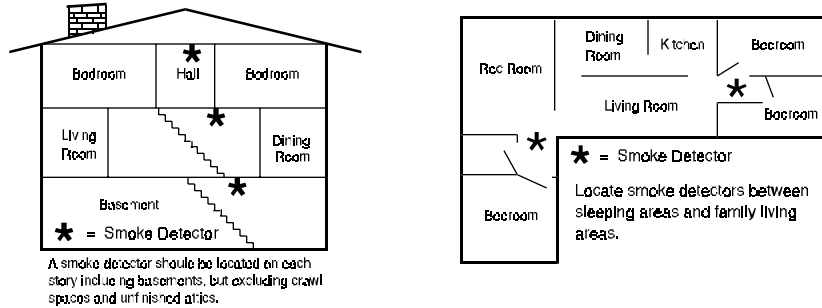

5.7 Personal Identification Numbers

The Personal Identification Number (PIN) is the 4 digit code users enter at the keypad to gain access to the system. A PIN may be assigned to each User Number 00 - 15. The User Number identifies each person using the system. There are 16 possible User Numbers (00 - 15). The Authority Level assigned to each User Number determines which functions each user will be able to perform.

Your system may have up to 16 different PINs, each 4 digits long. **Each User Number can have only one PIN.** Attempting to assign the same PIN to multiple User Numbers will result in the three-beep error tone, and the change will not be made.

User Number 00 is designated as a **Master Code**. It can be used to silence alarms, reset, bypass, and program the unit.

User Number 00 is shipped from the factory with the sequence of 9876. This code should be changed to one of your personal preference, and must be assigned maximum authority. PINs should never be programmed with common sequences such as 1111, 1234, or 2468 because they are easily violated.

Authority Levels

Authority Levels are assigned to PINs to determine which functions each user will be able to perform. Level 3 (minimum) will allow alarm silence and view history options only. Level 2 (medium) adds the capability to reset the system, access test modes, initiate fire drills, and disable input or output devices. Level 1 (maximum) adds the capability of programming the control panel. Level 0 (none) prevents all system access.

Level	Allowed Operations
Maximum (1)	all panel operations, including programming
Medium (2)	system test modes, fire drill, reset, disable, silence, view history
Minimum (3)	silence, view history
None (0)	none

5.8 Error Displays

Control panel problems are indicated by one of the following messages on the top line of the display. Contact your installing company if problems persist.

1. "FIRE ALARM" - One or more points is in alarm.
2. "SUPERVISORY ALARM" - A supervisory condition exists (e.g. a shut-off valve is closed).
3. "SYSTEM TROUBLE" - A trouble condition exists (e.g. wiring for a point is cut, AC power fails, etc.).
4. "POINT TROUBLE" - One of the points is not responding to the control panel. This may also be displayed during power-up (if so, ignore).
5. "DISABLED DEVICE" - An input or output device has been disabled.

5.9 Testing

Any of seven special test modes can be selected using the Test key found on the built-in and D7033 keypads.

- Walk test: Checks the points to assure that detectors connected to a point will report an alarm to the control. While in this mode, the LCD will show system test status and the trouble sounder will sound every 10 seconds.
- Communicator test: The communicator will send a test report. While communication is in progress, the Power LED will flash. When the communication succeeds, a long keypad beep will be heard, the Power LED will return to normal, and the display will return to normal.

NOTE: This test is available only if your system transmits alarms and system information to a monitoring service, and has been programmed by the security installing company to permit communicator tests.

5.0 Operating Guide (continued)

- Dial out for downloading: The control panel will dial out to the remote programmer. This test requires that phone number 3 (computer) and account code 1 be programmed.
- Test battery/NAC circuits: If a power failure occurs, your control panel has a built-in battery that will continue to power the system for several hours. The control panel automatically recharges the battery when power is restored. In this test mode, the system will operate the alarm relay and test the battery for 2 seconds. The test result will be displayed at the end of the test, and will not be reported to the central station. Pressing the Clear key or the Command key will return the display to standby mode, or the unit will time out after 20 seconds.
- Answer phone for downloading: Verifies the panel's ability to answer the phone line for remote programming. The remote computer must give the proper agency and remote passwords for connection to be maintained.
- Manually activate outputs: Allows a selected output to be turned on and turned off manually.
- Read zone input levels: Shows the status of a selected internal point. This status will be updated every five seconds. In addition, this test mode can be used to display line voltage, battery voltage, ground fault level, NAC current, and phone line level status.

5.10 Remote Program Dial-out and Answer

Call for Remote Programming

Phone numbers 1 and 3 must be programmed, along with account code 1. The panel will call phone number 3 and attempt to connect for downloading. While programming is underway, the Trouble LED will flash. If the panel is already using the phone line, it will sound the three beep error tone.

Answer for Remote Programming

The panel will immediately pick up the phone line to answer a remote programming call. While programming is underway, the Trouble LED will flash. In addition to allowing a connection for remote programming, this will allow on-site PC downloading. If the panel is already using the phone line for a report communication, it will sound the three beep error tone.

6.0 How to Program

The keypad will (under normal conditions) display "SYSTEM NORMAL" on the top line and, "SELECT:" on the bottom line, followed by the following scrolling menu items:

- PROG/O
- CMND/#
- TEST
- HISTORY
- DISABLE
- DRILL

Power Trouble
 Alarm Silenced

SYSTEM NORMAL
SELECT: PROG/O

To select one of the menu items, simply press its corresponding key on the keypad at any time.

When a menu item is selected, the Trouble LED will begin to flash and the display's backlighting will turn on.

When PROG/O, CMND/#, DISABLE, and TEST are selected, the menu item is displayed on the top line and the bottom line scrolls through sub-menu items.

Power Trouble
 Alarm Silenced

PROG MODES
1 - PROG TIMES

To return to the SYSTEM NORMAL display, press the [Clear/*] key.

To select a sub-menu, press the corresponding number key on the keypad.

The keypad may, at this time, prompt you to enter your PIN number. If so, enter the number and the display will automatically go to the sub-menu display.

Power Trouble
 Alarm Silenced

RESTRICTD ACCESS
ENTER PIN: _ _

Power Trouble
 Alarm Silenced

DATE/TIME
1 - SYSTEM

To return to a previous screen at any time, press the [Clear/*] key. Doing so deep within a sub-menu will eventually return you to the SYSTEM NORMAL display.

When a sub-menu item prompts you to enter data, do so followed by the [Cmnd/#] key. If data already exists at a particular location, it will be displayed. You can either accept that data or enter new data over it.

Power Trouble
 Alarm Silenced

ENTER DATE
MMDDYY: _01196

When the [Cmnd/#] key is pressed to enter the data, the display will return you to the sub-menu display you were in previously.

For a complete listing of each menu and sub-menu, see pages 19-21. For a listing of the Defaults, see pages 24 and 25.

The HISTORY option is not menu driven; rather it is a list. After you press the HISTORY key, the latest system event will be displayed.

Power Trouble
 Alarm Silenced

12/12 DRILL: OVER
08:13 101196

The "12/12" in our example means this is the 12th event out of 12. DRILL: OVER is the event, 08:13 is the time of the event, and 101196 is the date of the event.

The display will automatically scroll back through the events until it reaches the end, then will display the following:

Power Trouble
 Alarm Silenced

0/12
7-BACK 9-FORWARD

At any time during your viewing of the history, you can press the 7 or 9 keys to move forward or backward through the list of system events.

6.0 How to Program (continued)

6.1 ALPHA Programming

When programming the Point Descriptions (4- PROG INPUTS / 1- POINT NUMBER / 4- DESCRIPTION), the numeric keys are used to enter alpha-numeric information similar to the way telephone buttons are used to process information over the phone lines: each key representing 4 or more letters or symbols.

When you enter the Description programming section, the display will show the following:

- Power Trouble
- Alarm Silenced



Characters are displayed on the second line as they are entered. As each numeric key is pressed, it will enter a different character each time it is pressed. For example: repeatedly pressing the [2] key will enter **A, B, C, 2, A, B**, etc.

The numeric keys and their values are shown in the following table.

Numeric Key	Values			
1	Space	1	, ' & / # ! -	
2	A	B	C	2
3	D	E	F	3
4	G	H	I	4
5	J	K	L	5
6	M	N	O	6
7	P	R	S	7
8	T	U	V	8
9	W	X	Y	9
0	Q	Z	0	
#/CMD	enters the description and returns to programming menu			
*/CLEAR	returns to programming menu without entering changes			
SILENCE	moves cursor one space right			
DISABLE	moves cursor one space left			

6.2 Format Programming

6.2.1 4/2

When 4/2 format is used, reports generated by points consist of an event type (first digit) and a point number (second digit). Digits may be programmed for the following events: fire alarm, fire restoral, waterflow alarm, supervisory alarm, point trouble, trouble restore, point disable, disable restoral, and monitor alarm. The same event type (first digit) will be sent for any point. The point number is the second digit. Each point may be programmed to a different digit. This programming is done under 7- PROG FORMATS, 1- 4/2 POINT RPT.

Additionally, 18 system events may each be programmed with a unique two digit code. Events that may be programmed this way include, for example: system silence, fire drill, phone 1 trouble, and phone 2 restoral. This programming is done under 7- PROG FORMATS, 2- 4/2 RPT CODS.

6.2.2 BFSK

Similar to the programming of system events for 4/2 formats, five system events may be programmed for two unique digits each when the BFSK format is used. This programming is done under 7- PROG FORMATS, 3- BFSK RPT CODS.

6.2.3 SIA

The report that is sent by the SIA format when the panel is silenced may be programmed. By default, the panel will send "KB" when it is silenced. Any letters may be programmed to be sent for this condition. To program this, the number keys take the same letter assignments as they have for programming point descriptions.

7.0 Programming Menu Tree (PROG/0)

For defaults, see page 24

SELECT:					
PROG/0	CMND/#	TEST	HISTORY	DISABLE	DRILL
1- PROG TIME	2- SECURITY	3- PROG SYSTEM	4- PROG INPUTS		
<p>1- SYSTEM MMDDYY HHMM</p> <p>2- AUTO TEST</p> <p>1- TEST TIME: Time of day the automatic test occurs.</p> <p>2- TEST FREQ: Intervals the automatic test reports are sent. e.g. 7 days. The first report will be sent when the test time occurs, then every 7 days thereafter.</p>	<p>1- PINS</p> <p>1- PROGRAMR: Code used by installer to configure and operate the panel. Factory default code is "9876" and may be changed at any time.</p> <p>2- USERS: Up to 15 additional user codes can be programmed for the unit to protect the system from unauthorized operation and allow a record to be kept of actions by individual system users.</p> <p>2- AUTHORITY: Determines which system actions a user can perform.</p> <p>USER (01 - 15)</p> <p>0- NONE 1- MAXIMUM 2- MEDIUM 3- MINIMUM</p>	<p>1- CITY BOX: Reconfigures the system to use notification appliance circuit 2 as a signaling circuit to drive a city box interface for a municipal fire alarm reporting system. YES (1) NO (0)</p> <p>2- TIMERS</p> <p>1- SMOKE RESET: Time the smoke detector power is turned off after reset. No alarms are registered by the system for 5 seconds after power is turned back on. (01 - 16 seconds)</p> <p>2- AC FAIL DLY: The # of hours the control will wait after an AC failure before sending an AC Fail report. A setting of "1" causes the system to send a report when the battery reaches 25% of capacity. 1- WAIT FOR TIME 2- ENTER TIME (00 - 24 Hours)</p> <p>3- AUTO SILENCE: Sets the time for an autosilence NAC to activate until it silences itself. The same setting applies to all NACs. (00 - 99 Minutes)</p> <p>4- (reserved)</p> <p>5- DISPLAY RATE: The speed menus are shown on the LCD screen, in units of 1/4 second. (01 - 16 x .25)</p> <p>3- (reserved)</p> <p>4- OPTION BUS</p> <p>1- UPDATE BUS: Queries both option buses and updates list of connected devices.</p> <p>2- SETUP KEYPAD: Tells the system how many keypads should be supervised. (0 - 4 Keypads)</p> <p>5- PIN REQUIRED?: A PIN can be required before operations can be performed.</p> <p>1- LOCAL YES (1) NO (0)</p> <p>2- REMOTE YES (1) NO (0)</p> <p>6- REPORT/MONI.: Communicator and phone monitoring hardware can be disabled or enabled. YES (1) NO (0)</p> <p>7- (reserved)</p>	<p>1- POINT NUMBER (1 - 4/8) Note: Point 4 has different defaults than the other points. See page 24.</p> <p>0- ALARM/TROUBLE</p> <p>1- ALARM: When a point goes into an open circuit state, the system alarms.</p> <p>2- TROUBLE: When point wiring is cut, AC power fails, etc., the system responds with a trouble condition.</p> <p>1- LATCHING: If a zone is non-latching, the system will reset alarm status automatically (but not reset smoke power) when the input restores to the standby condition. Other-wise, the system must be manually reset. YES (1) NO (0)</p> <p>2- VERIFICATION: Resets the detector once to see if the alarm recurs before annunciating or sending a signal. YES (1) NO (0)</p> <p>3- ZONE ASSIGN: Each input can be assigned to only one zone; however, multiple inputs can be assigned to the same zone. (00 - 63)</p> <p>4- DESCRIPTION: Each input (initiating circuit) can be labeled with a 16 character description to identify input.</p> <p>5- (reserved)</p> <p>6- LOOP RESPONSE: Configure points to activate with standard response time (setting 1) or one system-wide programmed response time (setting 2). 1- FAST: (500 ms) 2- PROGRAMMED</p> <p>7- SILENCABLE: Determines if a user can silence the system or not. When an output device is controlled by more than one point, if any non-silenceable point is active, the output becomes non-silenceable. YES (1) NO (0)</p> <p>8- LOCAL ONLY: The input point gives local annunciation only, with no communicator report. YES (1) NO (0)</p> <p>9- CONFIGURE</p> <p>1- FIRE: When activated, point displays "ALARM" on panel and keypads, activates selected output devices, and sends a fire alarm report (if programmed). Fire points have "silenceable," "latching," and "output zone 0" characteristics.</p> <p>2- WATERFLOW: When activated, point displays "WATERFLOW ALARM" on panel and keypads, activates selected output devices, and sends a waterflow alarm report (if programmed). Waterflow points have "non-silenceable," "latching," and "output point 0" characteristics.</p> <p>3- SUPERVISORY: When activated, point displays "SUPERVISORY ALARM" on panel and keypads, and sends a supervisory alarm report (if programmed). Supervisory points have "silenceable," and "non-latching," characteristics with no output points.</p> <p>4- MONITOR: When activated, point displays "MONITOR ALARM" on panel and keypads, activates selected output devices, and sends a fire alarm report (if programmed). If using the SIA format for communication to the central station, a "UA" alarm will be sent instead of a "FA" alarm. Monitor points have "silenceable" and "latching" characteristics with no output zones.</p> <p>5- RESET: When activated, point initiates a panel reset operation to clear alarms and reset smoke detectors.</p> <p>6- SILENCE: When activated, point initiates a panel silence operation to turn off sounders.</p> <p>7- (reserved)</p> <p>8- (reserved)</p>		

7.0 Programming Menu Tree (PROG/0 continued)

For defaults, see page 25

SELECT:

PROG/0	CMND/#	TEST	HISTORY	DISABLE	DRILL																								
5- PROG OUTPUTS	6- PROG ACCOUNTS		7- PROG FORMATS		8- HISTORY DEFAULTS																								
<p>1- NACS</p> <p>1- NAC #1</p> <p>1- AUTOSILENCE?: The NAC will silence itself after a specified time period. The system will remain in alarm. however, and must be manually reset. YES (1) NO (0)</p> <p>2- CONFIGURATION:</p> <p>1- STEADY: Output programmed to turn on steady for a fire alarm.</p> <p>2- PULSING: Output programmed to pulse for a fire alarm in the normal manner.</p> <p>3- TEMPORAL: Output programmed to pulse for a fire alarm in Temporal 3.</p> <p>4- CALIFORNIA: Output programmed to pulse for a fire alarm in the California Time cadence.</p> <p>3- ZONE ASSIGNS Each output can be assigned to up to 4 zones. ZONE A, B, C, or D (00=disabled) (1-63)</p> <p>2- NAC #2</p> <p>1- AUTOSILENCE</p> <p>2- CONFIGURATION</p> <p>1- STEADY 2- PULSING 3- TEMPORAL 4- CALIFORNIA</p> <p>3- ZONE ASSIGNS Each output can be assigned to up to 4 zones. ZONE A, B, C, or D (00=disabled) (1-63)</p> <p>2- RELAYS</p> <p>1- LOCAL</p> <p>1- RELAY #1 ZONE A, B, C, or D (00 - 63)</p> <p>2- RELAY #2 ZONE A, B, C, or D (00 - 63)</p> <p>2- REMOTE 1 (D7035) 1 - 8- RELAY #1 - #8 ZONE A, B, C, or D (00 - 63)</p> <p>3- REMOTE 2 SAME 1-8 OPTIONS AS REMOTE 1</p>	<p>1- ACCOUNT NUMS: The system can be programmed to report different account codes to each of the two reporting numbers. Account code 1 is used w/phone #1; account code 2 is used w/phone #2. 1- NUMBER 1: New Number 2- NUMBER 2: New Number</p> <p>2- PHONE NUMS: The system can be programmed with 2 reporting phone #'s. Phone #1 is used w/line #1; phone #2 is used w/line #2. Downloading occurs on phone #3.</p> <p>1- PHONE #1 Phone Number 1</p> <p>2- PHONE #2 Phone Number 2</p> <p>3- COMPTR PHONE: Sets the number to call for downloading.</p> <p>3- PHON CONTROL</p> <p>1- PHONE #1: Selects which communication format to use or disables communication for the phone number.</p> <p>1- FORMAT</p> <p>0- DISABLE 1- SIA, 110 2- CONTACT ID 3- BFSK 4- 4/2 TONE BST 5- 3/1 TONE BST 6- SIA, 300</p> <p>2- MONITOR LINE: Phone line monitor feature can be disabled for each phone line. YES (1) NO (0)</p> <p>3- TONE FREQ:</p> <table border="1"> <tr><td>19D</td><td>1900 Hz data tone</td></tr> <tr><td>18D</td><td>1800 Hz data tone</td></tr> <tr><td>14A</td><td>1400 Hz acknowledge tone</td></tr> <tr><td>23A</td><td>2300 Hz acknowledge tone</td></tr> <tr><td>10PS</td><td>10 pulses per second</td></tr> <tr><td>20PS</td><td>20 pulses per second</td></tr> <tr><td>40PS</td><td>40 pulses per second</td></tr> </table> <p>4- DIALING TYPE: Determines what format the panel will dial phone #'s 1,2, and 3.</p> <p>1- PULSE ONLY 2- TONE ONLY 3- TONE PULSE</p> <p>2- PHONE #2 SAME 1-5 OPTIONS AS PHONE #1</p> <p>4- RPT STEERING: Different classes of reports can be directed to different phone numbers.</p> <p>1- NONSUP ALRM 1- PHONE 1 ONLY: Report sent to phone #1 only. 2- PHONE 2 ONLY: Report sent to phone #2 only. 3- PHONE 1 AND 2: Report sent to ph #'s 1 and 2. 4- PHONE 2 BACKUP: Report sent to phone #1, then to phone #2 if #1 fails. 5- NO REPORT: No report sent.</p> <p>2- SUPVSRV ALRM 3- NONSUP RSTR 4- SUPVSRV RSTR 5- TROUBLE 6- TESTS 7- SILENCE 8- RESET 9- FIRE DRILL: Options 2 - 9 have the same choices as 1.</p> <p>5- RING COUNT: The number of phone rings before the panel will seize the line to attempt downloading.</p> <p>6- COMM. TRIES: The system will always attempt 10 times to communicate an event. The parameter determines after which attempt the system will indicate a communication failure condition. (01 - 10)</p> <p>7- MACH. BYPASS: The downloading computer dials back if an answering machine answers the phone before the control. If the control detects the phone line ringing within one minute of when the last ringing cycle stopped, then it will answer on the first ring and seize the phone line. YES (1) NO (0)</p>		19D	1900 Hz data tone	18D	1800 Hz data tone	14A	1400 Hz acknowledge tone	23A	2300 Hz acknowledge tone	10PS	10 pulses per second	20PS	20 pulses per second	40PS	40 pulses per second	<p>This section requires the used of hex digits (0 through F). Because the specific keys A through F are not available on the keypad, the following keys have been substituted: [Hisor] = A [Test] = B [Disable] = C [Drill] = D [Silence] = E [Reset] = F</p> <p>1- 4/2 POINT RPT</p> <p>0- FIRE ALRM D1 1- FIRE RSTR D1 2- WATERFLOW D1 3- SUPERVISE D1 4- TROUBLE D1 5- TRBL RSTR D1 6- DISABLE D1 7- DSBL RSTR D1 8- MONITOR D1 9- MORE</p> <p>1- POINT 1 D2 2- POINT 2 D2 3- POINT 3 D2 4- POINT 4 D2 5- POINT 5 D2 6- POINT 6 D2 7- POINT 7 D2 8- POINT 8 D2 9- MORE</p> <p>2- 4/2 RPT CODS</p> <p>0- SYSTM IN TST 1- SYS TEST RST 2- SILENCE 3- FIRE DRILL 4- FIRE DRL RST 5- OPEN RST RPT 6- LOW BATTERY 7- LOW BATT RST 8- AC FAILURE 9- MORE</p> <p>0- AC FAIL RST 1- TEST REPORT 2- OFF NORM TST 3- PHONE 1 TRBL 4- PN 1 TRB RST 5- PNONE 2 TRBL 6- PN 2 TRB RST 7- SYSTEM TROUB 8- SYS TRB RST</p> <p>3- BFSK RPT CDS</p> <p>1- OFF NRM TST 2- OPEN/RESET 3- SILENCE 4- FIRE DRILL 5- FIR DRIL RSTR</p> <p>4- SIA SIL RPT</p> <p>1- LEFT BYTE 2- RIGHT BYTE</p>		<p>1- CLEAR HSTRY The history buffer holds the latest 99 events. It automatically deletes the oldest items when it fills to 99. If you want to manually clear the history buffer, use this menu item.</p> <p>2- DEFAULT EE This menu item sets the EEPROM memory to the factory default values.</p> <p>3- ALT 4/2 CDES This menu item defaults the 4/2 reporting codes to an alternate industrv-standard set of reports. The alternate default is as follows (see page 25 for the standard defaults):</p> <p>4/2 POINT RPT</p> <p>0- FIRE ALRM: 0 1- FIRE RSTR: 2 2- WATERFLOW: 0 3- SUPERVISE: 0 4- TROUBLE: 6 5- TRBL RSTR: 7 6- DISABLE: 5 7- DSBL RSTR: 2 8- MONITOR: 0 9- MORE</p> <p>1- POINT 1: 1 2- POINT 2: 2 3- POINT 3: 3 4- POINT 4: 4 5- POINT 5: 5 6- POINT 6: 6 7- POINT 7: 7 8- POINT 8: 8 9- MORE</p> <p>4/2 RPT CODS</p> <p>0- SYSTM IN TST: 33 1- SYS TEST RST: 37 2- SILENCE: 9F 3- FIRE DRILL: 33 4- FIRE DRL RST: 37 5- OPEN RST RPT: 9F 6- LOW BATTERY: 69 7- LOW BATT RST: 79 8- AC FAILURE: 60 9- MORE</p> <p>0- AC FAIL RST: 70 1- TEST REPORT: 30 2- OFF NORM TST: 33 3- PHONE 1 TRBL: 31 4- PN 1 TRB RST: 35 5- PNONE 2 TRBL: 32 6- PN 2 TRB RST: 36 7- SYSTEM TROUB: 33 8- SYS TRB RST: 37</p>										
19D	1900 Hz data tone																												
18D	1800 Hz data tone																												
14A	1400 Hz acknowledge tone																												
23A	2300 Hz acknowledge tone																												
10PS	10 pulses per second																												
20PS	20 pulses per second																												
40PS	40 pulses per second																												
<p><i>For pre-assigned zones, see chart in lower right corner of this page.</i></p>																													
<table border="1"> <thead> <tr> <th colspan="2">Pre-assigned Zones</th> </tr> </thead> <tbody> <tr><td>Zone 63</td><td>General Alarm</td></tr> <tr><td>Zone 62</td><td>General Trouble</td></tr> <tr><td>Zone 61</td><td>General Waterflow</td></tr> <tr><td>Zone 60</td><td>No AC</td></tr> <tr><td>Zone 59</td><td>Alarm Verification</td></tr> <tr><td>Zone 58</td><td>General Supervisory Alarm</td></tr> <tr><td>Zone 57</td><td>Communication Trouble</td></tr> <tr><td>Zone 56</td><td>Pre-signal or Alarm Investigation Delay Active</td></tr> <tr><td>Zone 55</td><td>Releasing Cycle Started</td></tr> <tr><td>Zone 54</td><td>Activates for Ground Start</td></tr> <tr><td>Zone 53</td><td>General Fire</td></tr> </tbody> </table>						Pre-assigned Zones		Zone 63	General Alarm	Zone 62	General Trouble	Zone 61	General Waterflow	Zone 60	No AC	Zone 59	Alarm Verification	Zone 58	General Supervisory Alarm	Zone 57	Communication Trouble	Zone 56	Pre-signal or Alarm Investigation Delay Active	Zone 55	Releasing Cycle Started	Zone 54	Activates for Ground Start	Zone 53	General Fire
Pre-assigned Zones																													
Zone 63	General Alarm																												
Zone 62	General Trouble																												
Zone 61	General Waterflow																												
Zone 60	No AC																												
Zone 59	Alarm Verification																												
Zone 58	General Supervisory Alarm																												
Zone 57	Communication Trouble																												
Zone 56	Pre-signal or Alarm Investigation Delay Active																												
Zone 55	Releasing Cycle Started																												
Zone 54	Activates for Ground Start																												
Zone 53	General Fire																												

8.0 Menu Tree (CMND#, TEST, HISTORY, DISABLE, DRILL)

SELECT:					
PROG/0	CMND/#	TEST	HISTORY	DISABLE	DRILL
	0- PROG MODES SAME AS <PROG/0>	1- WALK TEST 1- SHORT ACTIVE <*/CLEAR> TO END 2- LONG ACTIVE <*/CLEAR> TO END 3- NO ACTIVATE <*/CLEAR> TO END	7- BACK	1- DISABLE 1- INPUTS 1- ALL 2- INDIVIDUAL (1 - 4/8) 2- OUTPUTS 1- NACs 1- LOCAL 1- NAC #1 DEVICE DISABLED 2- NAC #2 DEVICE DISABLED 2- LOCAL EXPAND 1- NAC #1 DEVICE DISABLED 2- NAC #2 DEVICE DISABLED 2- RELAYS 1- LOCAL 1- RELAY #1 DEVICE DISABLED 2- RELAY #2 DEVICE DISABLED 2- REMOTE 1 OPTIONS 1 - 8 ARE FOR RELAYS 1 - 8. DEVICE DISABLED 3- REMOTE 2 SAME 1 - 8 OPTIONS AS REMOTE 1. 3- DIALER	<*/CLEAR TO END
	8- TEST MODES SAME AS <TEST>	2- TEST COMM. 3- DIAL OUT 4- TEST BAT/NAC TEST PASSED/FAILED 5- ANSWER PHONE 6- TEST OUTPUTS 1- NACs 1- LOCAL 1- NAC #1 1- ON, 0- OFF 2- NAC #2 1- ON, 0- OFF 2- LOCAL EXPAND 1- NAC #1 1- ON, 0- OFF 2- NAC #2 1- ON, 0- OFF 2- RELAYS 1- LOCAL 1- RELAY #1 1- ON, 0- OFF 2- REMOTE 1 OPTIONS 1 - 8 ARE FOR RELAYS 1 - 8. 1- ON, 0- OFF 3- REMOTE 2 SAME 1 - 8 OPTIONS AS REMOTE 1. 7- TEST INPUTS POINT NUMBER (1 - 4/8) 1- PREV INPUT 2- NEXT INPUT	9- FORWARD	2- ENABLE SAME 1 - 3 OPTIONS AS DISABLE.	

9.0 Installation Guide for U.L. Listed Systems

9.1 D7024 U.L. Listings

The D7024 is U.L. Listed for the following:

- Commercial Fire Alarm (Type Service: Local, Central Station, and Remote Station; Type Initiating: Automatic, Manual, Sprinkler Supervisory, and Waterflow), U.L. Standard UL864.

The control panel should be installed in accordance with NFPA 72 for Commercial Fire installations.

9.2 Installation Considerations

- Failure to install and program the control in accordance with the requirements in this section voids the listing mark of Underwriters Laboratories, Inc.
- The standby battery capacity is 35 AH @ 24 VDC.
- The total nominal current must not exceed 970 mA in standby nor 4 A when in alarm.
- The control must be mounted indoors and within the protected area.
- Grounding must be in accordance with article 250 of the NEC (NFPA 70).
- Zones must be connected to U.L. Listed, compatible devices.
- The ground wire provided with the enclosure must be connected between the door and the enclosure using the supplied nuts.
- The ground start feature shall not be programmed.
- Phone monitoring must be selected if the DACT (Digital Alarm Communicator Transmitter) feature is used.

9.3 Programming the D7024

When used in U.L. Listed installations, the control must conform to certain programming requirements. The following is a list of the required program entries and required accessories for specific U.L. Listed installations.

Commercial Fire Alarm (Central Station (DACT) and Local)

Required Accessories:

- At least one Radionics, Inc. Model D285 smoke detector with a D287, D288, D292, or D293 Series base; or another Listed compatible smoke detector.
- At least one Radionics D601S horn/strobe or D443 bell (will provide 85 db for UL985 and NFPA 72 requirements; other Listed compatible devices with a voltage range of 20 to 31 V may be used) is required for this application and must be installed inside the protected area.

- Four-wire detectors must be used with Listed power supervision devices. A compatible Listed 4-wire detector is the Radionics, Inc. D285 in a D292 or D293 Series base. A compatible Listed EOL relay is the Radionics, Inc. D275.
- All points must be used with the EOL resistor provided.

A. Report Programming:

- Non-supervisory and supervisory reports must be programmed for those points used.
- Trouble reports must be programmed.
- AC failure report delay must be set for 75% of estimated standby time, or set to report at 25% of battery capacity.
- Automatic test report frequency must be set at least every 24 hours.

B. Timer Programming:

- Autosilence time must be programmed for not less than 5 minutes.

C. Point Programming:

- For fire points: open = trouble, latching.

D. Alarm Output Programming:

- Notification Appliance Circuits must be programmed to activate from the appropriate input points.

E. Communications Programming (if Used for Central Station Service):

- Central Station report/monitor must be enabled.
- Monitoring of both phone lines must be enabled.

9.4 Reversing Modules

A. D132:

The D132 Smoke Detector Reversing Relay Module allows the D7024 Control/Communicator to sound all smoke detectors connected to Point 1 when a single detector on the loop goes into alarm. To restore the detectors to normal, reset the sensors.

B. D185:

The D185 Reverse Polarity Module is a UL Listed module that connects the control panel with either a single set or a pair of leased Telephone Company (Telco) lines in NFPA 72 remote station applications. It relays system alarm status information from the panel to a monitoring station. The D185 operates with either 12 or 24VDC supply.

Appendix A: Abbreviations on Panel Display

3/1 = 3/1 Tone Burst (reporting format)

4/2 = 4/2 Tone Burst (reporting format)

7035 = D7035 Remote Relay Board

@ = Option Bus Address (1 - 16)

ACTVTN = Activation

A, ALRM = Alarm

ALT = Alternate

ANN, ANUN = Annunciator

BAT, BATT, BATTERY = Battery

BX = Box (e.g. City Box)

CATE = Catastrophe

CDES, CODS, CDS = Codes

CMPTR = Computer

COMM = Communicator

CONFIG = Configure

DESCRIPTION = Description

DIG = Digit

DLY = Delay

DRL, DRIL = Drill

D, DSBL, DISABL = Disable

DSPLY = Display

EE = EEPROM

ENAC = Expander NAC

EXP = Expander

FAIL = Failure

FIR, FR = Fire

FLT = Fault

FRQNCY, FREQ, FREQNCY = Frequency

FUNC = Function

GRND = Ground

HI = High

HSTRY = History

INIT = Initialize

KPAD, KYPAD, KYPD = Keypad

LNAC = Local NAC

LOC = Local

MACH = Answering Machine

MONI, MON = Monitor

NAC = Notification Appliance Circuit

NMBR, NUM = Number

NONSUP = Non-Supervisory

NORM, NRM = Normal

OUT = Output

OVRC = Overcurrent

PAS = Positive Alarm Sequence

PHN, PHON = Phone

PROG, PRGMNG = Programming

PRGRMMD = Programmed

PT, PNT = Point

PWR = Power

REM, REMOT = Remote

RESPNS = Response

RLY = Relay

RPRT, RPT = Report

RST = Restore

SIL = Silence

SMK = Smoke

SUPERVSORY, SUPRVSRY, SUPV, SPV, SUPVSY = Supervisory

SHRT = Short

SYS, SYSTM = System

T, TRBL, TRB, TROUB = Trouble

TST = Test

VER = Version

WFLW, WTF = Waterflow

ZN, ZON = Zone

Appendix B: Defaults for PROG/0

SELECT:					
PROG/0	CMND/#	TEST	HISTORY	DISABLE	DRILL
1- PROG TIME	2- SECURITY	3- PROG SYSTEM	4- PROG INPUTS		
1- SYSTEM Last date in EE 0000 2- AUTO TEST 1- TEST TIME: 0200 2- TEST FREQ: 24 hours	1- PINS 1- PROGRAMR: 9876 2- USERS: User 1 = 1234 User 2-15 = 0000 2- AUTHORITY: User 1 = 3 (max) User 2-15 = 0 (none)	1- CITY BOX: NO 2- TIMERS 1- SMOKE RESET: 5 seconds 2- AC FAIL DLY: 6 hours 3- AUTO SILENCE: 4 minutes 4- (reserved) 5- DISPLAY RATE: 4 x .25 = 1 second. 3- (reserved) 4- OPTION BUS 1- UPDATE BUS: Queries both option buses and updates list of connected devices. 2- SETUP KEYPAD: 0 5- PIN REQUIRED 1- LOCAL: NO 2- REMOTE: YES 6- REPORT/MONL.: YES 7- (reserved)	1- POINT NUMBER (1 - 4/8) 0- ALARM/TROUBLE: Trouble on Open 1- LATCHING: YES (Point 4 = NO) 2- VERIFICATION: NO 3- ZONE ASSIGN: Zone 1 = 1 Zone 2 = 2. etc. 4- DESCRIPTION: 5- (reserved) 6- LOOP RESPONSE: 1- FAST: Fast is the default (Point 4 = 10) 2- PROGRAMMED: When selected: 10 7- SILENCABLE: NO 8- LOCAL ONLY: NO 9- CONFIGURE: Fire (Point 4 = Waterflow)		

Appendix B: Defaults for PROG/0 (continued)

SELECT:					
PROG/0	CMND/#	TEST	HISTORY	DISABLE	DRILL
5- PROG OUTPUTS 1- NACS 1- NAC #1 1- AUTOSILENCE?: YES 2- CONFIGURATION: Pulsing 3- ZONE ASSIGNS Zone A = 63 Zone B = 0 Zone C = 0 Zone D = 0 2- NAC #2 1- AUTOSILENCE? NO 2- CONFIGURATION: Steady 3- ZONE ASSIGNS Zone A = 62 Zone B = 0 Zone C = 0 Zone D = 0 2- RELAYS 1- LOCAL 1- RELAY #1: Zone A = 62 Zone B = 0 Zone C = 0 Zone D = 0 2- RELAY #2 Zone A = 63 Zone B = 0 Zone C = 0 Zone D = 0 2- REMOTE 1 (D7035) Relav1/Zone A = 63 Relav2/Zone A = 62 Relav3/Zone A = 61 Relav4/Zone A = 60 Relav5/Zone A = 58 Relav6/Zone A = 57 Relav7/Zone A = 56 Relav8/Zone A = 53 3- REMOTE 2 Relav1/Zone A = 1 Relav2/Zone A = 2 Relav3/Zone A = 3 Relav4/Zone A = 4 Relav5/Zone A = 5 Relav6/Zone A = 6 Relav7/Zone A = 7 Relav8/Zone A = 8	6- PROG ACCOUNTS 1- ACCOUNT NUMS 1- NUMBER 1: A8A8 2- NUMBER 2: A8A8 2- PHONE NUMS 1- PHONE #1: FFFF... 2- PHONE #2: FFFF... 3- COMPTR PHONE: FFFF... 3- PHON CONTROL 1- PHONE #1: 1- FORMAT: 4/2 2- MONITOR LINE: YES 3- PULSE RATE: 10PPS 4- TONE FREQ: 1900/1400 5- DIALING TYPE: Pulse Only 1- PHONE #1: 1- FORMAT: 4/2 2- MONITOR LINE: YES 3- TONE FREQ: 1900/1400 4- DIALING TYPE: Pulse Only 4- RPT STEERING 1- NONSUP ALRM: PHN 2 BCKUP 2- SUPVSRV ALRM: PHN 2 BCKUP 3- NONSUP RSTR: PHN 2 BCKUP 4- SUPVSRV ALRM: PHN 2 BCKUP 5- RESET: PHN 2 BCKUP 6- SILENCE: PHN 2 BCKUP 7- TESTS: PHN 2 BCKUP 8- TROUBLE: PHN 2 BCKUP 9- FIRE DRILL: PHN 2 BCKUP 5- RING COUNT: 15 6- COMM. TRIES: 10 7- MACH. BYPASS: YES	7- PROG FORMATS 1- 4/2 POINT RPT 0- FIRE ALRM D1: 0 1- FIRE RSTR D1: 3 2- WATERFLOW D1: 0 3- SUPERVISE D1: 0 4- TROUBLE D1: 6 5- TRBL RSTR D1: 3 6- DISABLE D1: B 7- DSBL RSTR D1: 3 8- MONITOR D1: 0 9- MORE 1- POINT 1 D2: 1 2- POINT 2 D2: 2 3- POINT 3 D2: 3 4- POINT 4 D2: 4 5- POINT 5 D2: 5 6- POINT 6 D2: 6 7- POINT 7 D2: 7 8- POINT 8 D2: 8 9- MORE 2- 4/2 RPT CODS 0- SYSTM IN TST: F1 1- SYS TEST RST: E1 2- SILENCE: 9F 3- FIRE DRILL: F2 4- FIRE DRL RST: E2 5- OPEN RST RPT: 9F 6- LOW BATTERY: F9 7- LOW BATT RST: E9 8- AC FAILURE: FA 9- MORE 0- AC FAIL RST: EA 1- TEST REPORT: EE 2- OFF NORM TST: FD 3- PHONE 1 TRBL: FB 4- PN 1 TRB RST: EB 5- PNONE 2 TRBL: FC 6- PN 2 TRB RST: EC 7- SYSTEM TROUB: FD 8- SYS TRB RST: FD 3- BFSK RPT CDS 1- OFF NRM TST: FD 2- OPEN/RESET: FD 3- SILENCE: FD 4- FIRE DRILL: FD 5- FIR DRIL RSTR: ED 4- SIA SIL RPT 1- LEFT BYTE: 42 'K' 2- RIGHT BYTE: 42 'B'	8- HISTORY DEFAULTS 1- CLEAR HSTRY 2- DEFAULT EE 3- ALT 4/2 CDES		

Index

Symbols

2-wire Circuits 4
4/2 18, 20, 25

A

Abbreviations 23
Alarm Operation 12
alpha-numeric LCD keypad 11
ALPHA Programming 18
Authority Level 15
Auxiliary Power 4

B

Backlight Control 11
Backup Battery Calculation 5
battery, Test 16
BFSK 18, 20, 25

C

Circuit Voltage Range 4
CMND# 21
CMND/# 17
Codes, User 4
Commercial Fire Alarm 22
Communicator test 15
Control Terminal Wiring 7
Current, Standby 4
Current, Supervisory 4

D

D132 22
D185 22
D7033 Keypad 11
D7035 4
Defaults 24, 25
DISABLE 17, 21
Displays, Error 15
DRILL 17, 21

E

Enclosure 6
enclosure 4
End-of-Line Resistor 4
Error Displays 15
Escape Plan 14

F

Fire Safety 13
Fire Silence/Reset 13
Format Programming 18

H

HISTORY 17, 21
How to Program 17

I

Initiating Circuit (Smoke) Power 4
Initiating Circuits 4
Input Power 4
Installation Considerations 14, 22

K

Keypad 11
Keypad, D7033 11
Keypads 5

L

Lightning Protection 5
Local Relays 4

M

Mapping 12
Master Code 15
Maximum Detectors per Zone 4
Maximum Line Resistance 4
Maximum Short Circuit Current 4
Menu Tree 21

N

Normal Operation 12
Notification Appliance Circuit Power 4

O

Operating Guide 11, 12, 13, 14, 15
Option Bus Power 4
Optional Standby Batteries 4
Output Zones 12
Outputs 4

P

Panel Display 23
Personal Identification Numbers 15
Phone numbers 16
PIN 15
PIN number 5, 17
Point/Zone Mapping 12
Power 4
Power, Auxiliary 4
Power, Input 4
PROG/0 17, 19, 20
Programming Menu Tree 19, 20

Index (continued)

R

Relays, Local 4
Remote Program Dial-out and Answer 16
Remote Relay Module 4
Required Current for Alarm 4
Response Time 4
Reversing Modules 22

S

SIA 18, 20, 25
standby battery capacity 5
Standby Current 4
Standby Current Load 5
Supervisory Current 4
system operation 12
System Trouble 13
System Worksheet 8, 9, 10

T

Temperature 4
TEST 17, 21
Testing 15
Time, Response 4
Trouble Operation 12
Trouble, System 13

U

U.L. 22
User Codes 4
User Number 15
Users 5

V

Volume Control 11

W

Walk test 15

Z

Zones 12

TMThe Radionics logo is a registered trademark of Radionics, Inc., Salinas, CA, U.S.A. ©1997 Radionics, Inc., Salinas, CA, U.S.A. All rights reserved



Radionics, Inc., 1800 Abbott Street
Salinas, California 93901
Customer Service: (800) 538-5807